



BETON

2 0 2 5
LEVERINGS
PROGRAMMA



architectonisch beton

www.bsbeton.nl

Projecten



De Wending

Delfzijl
5500 m¹ betonbanden



Projecten

Van Haren
Sneek



Varkensmarkt
Amersfoort



Hieronder vindt u een indicatie van de standaard en mogelijke projectmatige kleuren



standaard grijs



antraciet



mogelijke projectmatige kleuren

Inhoudsopgave

Raamdorpels	4
Spekbanden / Spuwer	8
Lateien	10
Muurafdekken	12
Overzicht aansluitende producten	17
Penantafdekken / Schoorsteenplaten	18
Schoorsteenplaten	20
Ornamenten	22
Kantplanken	25
Bloktreden	26
Poeren	27
Deuromlijstingen	28
Raamkaders	30
Verwerkingsadvies / hoekstukken	32
Toeslagen	33



Raamdorpels

Toepassing:

- aansluiting tussen kozijndorpel en metselwerk.

Voordelen:

- snelle montage.
- voorkomt het optrekken van vocht.

Uitvoering:

- betonoppervlak conform klasse A.
- maximale lengte 1500 mm.
- variabele lengte mogelijk.
- met of zonder waterhol.
- kleur grijs of antraciet.
- andere kleuren projectmatig mogelijk.
- afwijkende maatvoering op aanvraag.

Opties:

- verstek 45°.
- hoekstuk 90°.
- verstek afwijkend.
- sparing.
- schroefhuls stortzijde.

Verwerking:

- in mortel te leggen en voegen van 10 mm te hanteren. Voegen afwerken met flexibele kit.

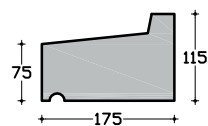
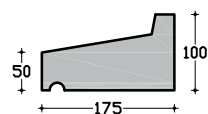
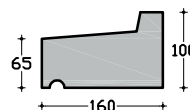
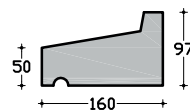
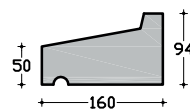
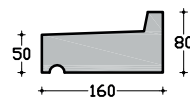
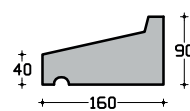
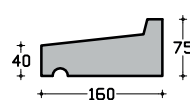
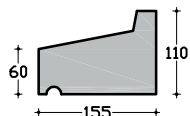
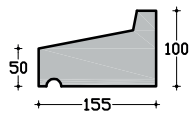
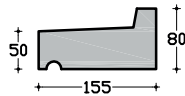
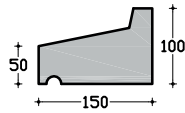
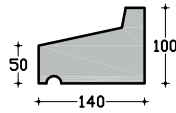
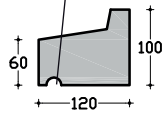
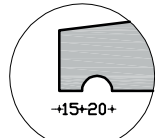

Art. nummer	Stuks per pallet	Gewicht per m ¹	A	Prijs m ¹ grijs	Prijs m ¹ antraciet
RD120A	42	22	25	€ 25,97	€ 38,98
RD140A	32	24	25	€ 26,60	€ 39,89
RD150A	32	25	25	€ 27,18	€ 40,78
RD155A	32	21	25	€ 27,18	€ 40,78
RD155B	28	26	25	€ 27,80	€ 41,70
RD155C	28	30	25	€ 28,99	€ 43,48
RD160H	32	20	20	€ 29,20	€ 43,79
RD160J	28	23	20	€ 29,25	€ 43,87
RD160A	32	22	20	€ 28,99	€ 43,48
RD160G	28	25	25	€ 29,30	€ 43,96
Aansluitend op spekband type SBA150A					
RD160F	28	25	25	€ 29,30	€ 43,94
Aansluitend op spekband type SBA150A					
RD160B	28	29	30	€ 29,61	€ 44,40
RD175A	28	29	25	€ 30,19	€ 45,31
RD175B	28	37	30	€ 30,19	€ 45,31



Toeslagen zie pagina 33.

Raamdorpels / Deurdorpels

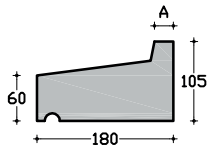

Art. nummer	Stuks per pallet	Gewicht per m ¹	A	Prijs m ¹ grijs	Prijs m ¹ antraciet
RD180A	28	33	25	€ 30,80	€ 46,21
RD200A	28	35	20	€ 32,63	€ 48,92
RD240B	14	53	20	€ 39,46	€ 55,84
RD240A	14	53	20	€ 40,70	€ 56,97
RD280A	14	52	25	€ 43,36	€ 59,83
RD300A	14	58	25	€ 46,79	€ 63,41

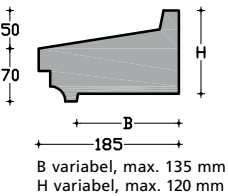
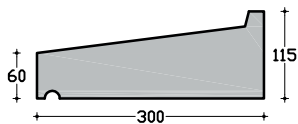
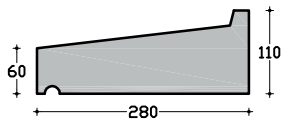
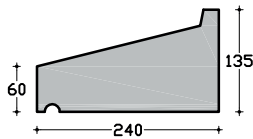
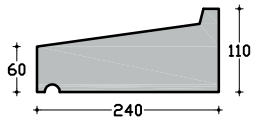
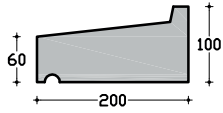

RDP185A	28	34	20	€ 57,20	€ 85,79
RDP210A	24	38	20	€ 63,28	€ 94,92

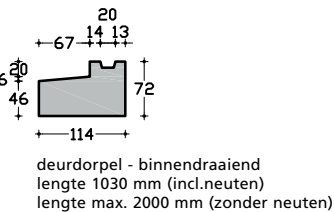
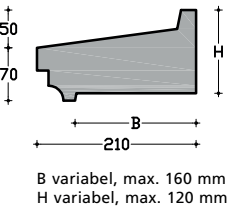

Art. nummer	Gewicht per m ¹	Prijs m ¹ grijs	Prijs m ¹ antraciet
DD114A	16	€ 26,43	€ 39,58
DD114B	16	€ 29,18	€ 43,73

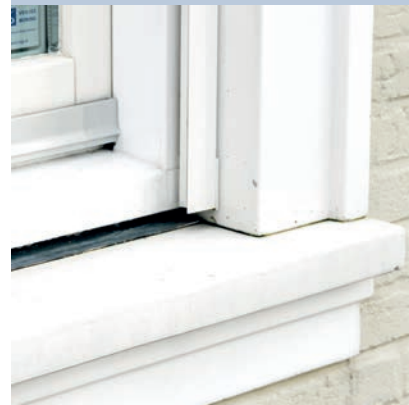
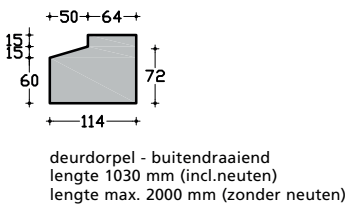

Raamdorpels serie

50 serie + 60 serie + 80 serie (zie voor meer informatie pagina 17)

Toepassing:

- aansluiting tussen kozijndorpel en metselwerk.

Voordelen:

- snelle montage.
- voorkomt het optrekken van vocht.

Uitvoering:

- betonoppervlak conform klasse A.
- maximale lengte 1500 mm.
- variabele lengte mogelijk.
- met of zonder waterhol.
- kleur grijs of antraciet.
- andere kleuren projectmatig mogelijk.
- afwijkende maatvoering op aanvraag.

Opties:

- verstek 45°.
- hoekstuk 90°.
- verstek afwijkend.
- sparing.
- schroefhuls stortzijde.

Verwerking:

- in mortel te leggen en voegen van 10 mm te hanteren. Voegen afwerken met flexibele kit.

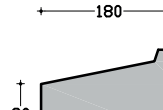
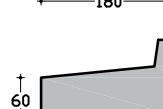
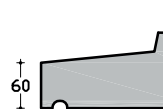
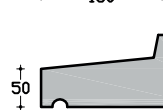
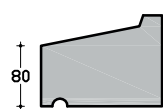
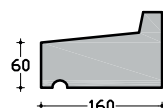
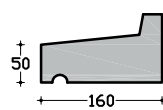
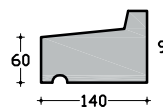
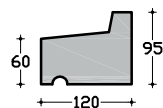
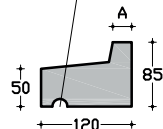
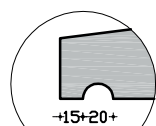

Art. nummer	Stuks per pallet	Gewicht per m ¹	A	Prijs m ¹ grijs	Prijs m ¹ antraciet
RD120B	42	18	25	€ 25,56	€ 38,33
RD120C	38	21	25	€ 25,74	€ 38,60
RD140B	32	24	25	€ 26,69	€ 40,04
RD160C	28	24	25	€ 29,30	€ 43,94
RD160D	28	24	25	€ 29,55	€ 44,33
RD160E	28	37	25	€ 31,39	€ 46,85
RD180B	28	28	25	€ 30,34	€ 45,52
RD180C	28	31	25	€ 30,78	€ 46,15
RD180D	28	35	25	€ 30,95	€ 46,41
RD180F	28	43	25	€ 37,51	€ 52,97





Spekbanden

Toepassing:

- sierband in de gevel. kan tevens in het verlengde van raamdorpels en/of muurafdekkers worden toegepast.

Voordelen:

- snelle montage.

Uitvoering:

- betonoppervlak conform klasse A.
- maximale lengte 1500 mm.
- variabele lengte mogelijk.
- met of zonder waterhol.
- kleur grijs of antraciet.
- andere kleuren projectmatig mogelijk.
- afwijkende maatvoering op aanvraag.

Opties:

- verstek 45°.
- hoekstuk 90°.
- verstek afwijkend.
- sparing.
- schroefhuls stortzijde.

Verwerking:

- in mortel te leggen en voegen van 10 mm te hanteren. Voegen afwerken met flexibele kit.

Deze producten kunnen niet voor dragende en/of constructieve doeleinden gebruikt worden.

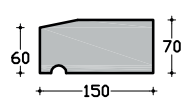
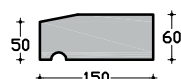
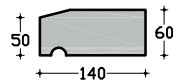
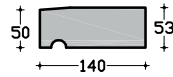
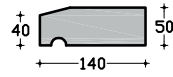
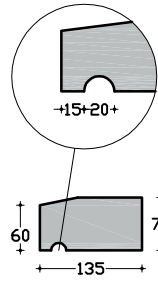

Art. nummer	Stuks per pallet	Gewicht per m ¹	Prijs m ¹ grijs	Prijs m ¹ antraciet
SBA135A	35	22	€ 27,47	€ 38,43
SBA140A	40	16	€ 26,61	€ 37,26
SBA140B	40	18	€ 27,40	€ 38,34
SBA140C	35	20	€ 27,55	€ 38,54
SBA150A	35	21	€ 27,73	€ 39,01
Aansluitend op raamdorpel type RD160G/RD160F				
SBA150B	35	25	€ 29,03	€ 40,64

50 serie + 60 serie + 80 serie [\(zie voor meer informatie pagina 17\)](#)

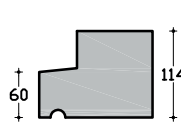
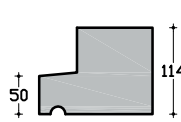
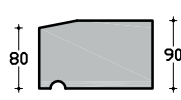
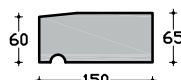
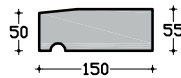

SBA150C	40	20	€ 27,81	€ 38,94
SBA150D	35	23	€ 29,03	€ 40,64
SBA150E	28	31	€ 29,49	€ 41,94
SBN150C	28	34	€ 30,25	€ 42,68
SBN150D	28	35	€ 30,49	€ 43,59



Toeslagen zie pagina 33.

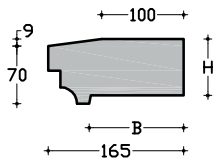
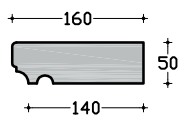

B variabel, max. 115 mm
H variabel, max. 79 mm

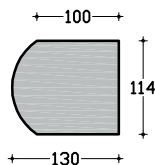
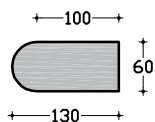

Art. nummer	Stuks per pallet	Gewicht per m ¹	Prijs m ¹ grijs	Prijs m ¹ antraciet
SBR160A	40	21	€ 38,09	€ 56,92
SBR165B	28	25	€ 59,28	€ 88,92
SBR130B	40	18	€ 30,95	€ 46,42
SBR130C	28	34	€ 33,20	€ 49,81

Art. nummer	H	B	Gewicht per m ¹	Prijs m ¹ grijs	Prijs m ¹ antraciet
SB50	50	100	12	€ 15,99	€ 24,00
SB55	55	100	14	€ 16,69	€ 25,04
SB60	60	100	15	€ 17,03	€ 25,56
SB70	70	100	17	€ 17,55	€ 26,34
SB83	83	100	20	€ 17,82	€ 26,75
SB90	90	100	22	€ 18,43	€ 27,64
SB114	114	100	28	€ 19,47	€ 29,21
SB120	120	100	29	€ 21,04	€ 31,56
SB150	150	100	36	€ 24,00	€ 35,98
SB176	176	100	43	€ 25,90	€ 38,85
SB185	185	100	45	€ 27,12	€ 40,67
SB250	250	100	60	€ 33,38	€ 50,07
SB310	310	100	75	€ 38,77	€ 58,15

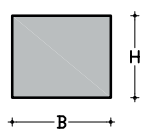

Spuwers

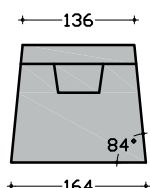

vooraanzicht

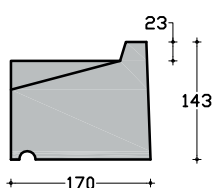

zijaanzicht

Art. nummer	Gewicht per st.	Prijs per stuk grijs	Prijs per stuk antraciet
SP164	9	€ 45,56	€ 65,01



Toepassing:

- Wordt toegepast als dragende constructie boven raam- en deursparingen in combinatie met het bovenliggende metselwerk. De belasting wordt door de gevelwerking in het metselwerk overgebracht naar de opleggingen.

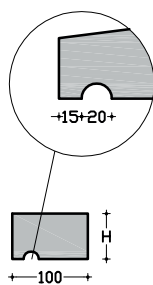

Uitvoering:

- betonoppervlak conform klasse A.
- 1-laags betonlatei 60,70, 83,100 mm, maximale lengte 3000 mm.
- 2-laags betonlatei 114, 120,150, 210 mm, maximale lengte 4000 mm.
- opleglengte latei <2000 mm: 150 mm.
- opleglengte latei >2000 mm: 200 mm.
- met of zonder waterhol.
- kleur grijs.
- andere kleuren projectmatig mogelijk.
- afwijkende maatvoering op aanvraag.

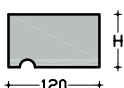

Opties:

- verstek 45°.
- verstek afwijkend.
- sparing.
- wegmetselbare oplegging.
- schroefhuls stortzijde.

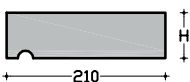

De constructieve verantwoordelijkheid ligt bij de opdrachtgever of hoofdconstructeur.

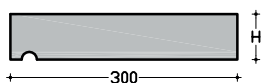

Art. nummer	B/H	Gewicht per m ¹	Prijs m ¹ grijs
LV100A	60	15	prijs op aanvraag
LV100B	70	17	€ 21,28
LV100C	83	20	€ 22,08
LV100D	100	24	€ 23,58
LV100E	114	28	€ 28,07
LV100F	120	29	€ 28,44
LV100G	150	36	€ 32,55
LV120G	60	18	€ 22,66
LV120A	70	20	€ 24,32
LV120B	83	24	€ 25,44
LV120C	114	33	€ 32,18
LV120D	120	35	€ 32,92
LV120E	150	44	€ 37,79
LV150G	60	22	€ 26,40
LV150A	70	26	€ 28,07
LV150B	83	30	€ 29,18
LV150C	100	36	€ 31,07
LV150D	114	41	€ 38,16
LV150E	120	43	€ 38,16
LV150F	150	54	€ 43,78
LV210A	60	30	€ 28,81
LV210B	70	35	€ 32,92
LV210C	83	42	€ 34,81
LV210D	114	58	€ 47,13
LV210E	120	61	€ 47,89
LV210F	150	76	€ 52,38
LV300A	60	43	€ 41,54
LV300B	70	51	€ 43,04
LV300C	83	60	€ 46,02
LV300D	114	82	€ 58,75
LV300E	120	87	€ 60,60

Andere afmetingen op aanvraag.
Beschikbaarheid in overleg.



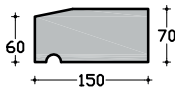
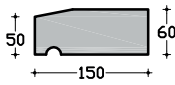
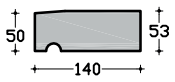

Art. nummer	Gewicht per m ²	Prijs m ² grijs	Prijs m ² antraciet
LS140A	18	€ 31,42	€ 44,00
LS150B	21	€ 32,06	€ 44,88
LS150D	24	€ 32,76	€ 45,86

50 serie + 60 serie + 80 serie (zie voor meer informatie pagina 17)

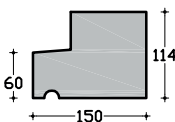
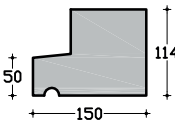
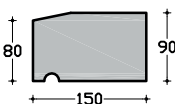
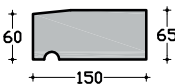
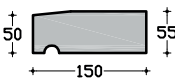

LS150A	19	€ 31,81	€ 44,54
LS150C	23	€ 32,22	€ 45,11
LS150E	32	€ 32,91	€ 46,08
LN150A	34	€ 47,49	€ 66,48
LN150B	35	€ 49,48	€ 69,28

Andere afmetingen op aanvraag.
Beschikbaarheid in overleg.



Muurafdekken

Toepassing:

- Het afdekken van een borstwering, kopgevel of gemetselde tuinmuren.

Voordelen:

- snelle montage.
- voorkomt vochtopname van het onderliggende metselwerk.

Uitvoering:

- betonoppervlak conform klasse A.
- maximale lengte 1500 mm.
- variabele lengte mogelijk.
- met of zonder waterhol.
- kleur grijs of antraciet.
- andere kleuren projectmatig mogelijk.
- afwijkende maatvoering op aanvraag.

Opties:

- verstek 45°.
- hoekstuk 90°.
- verstek afwijkend.
- eindstuk max. 1000 mm.
- sparing.
- conische sparing.
- spouwnok.
- schroefhuls stortzijde.

Verwerking:

- in mortel te leggen en voegen van 10 mm te hanteren. Voegen afwerken met flexibele kit.

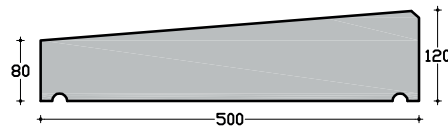
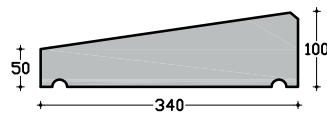
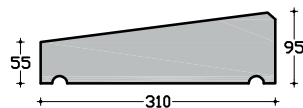
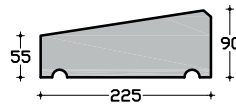
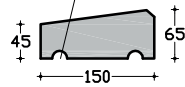
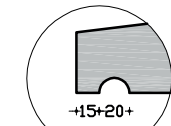

Art. nummer	Stuks per pallet	Gewicht per m ¹	Prijs m ¹ grijs	Prijs m ¹ antraciet
ABS15	35	19	€ 29,80	€ 41,21
ABS22,5	24	39	€ 33,20	€ 45,65
ABS31	14	55	€ 45,80	€ 64,24
ABS34	14	61	€ 50,15	€ 70,14
ABS50	14	120	€ 85,76	€ 120,05



Muurafdekken serie

50 serie + 60 serie (zie voor meer informatie pagina 17)

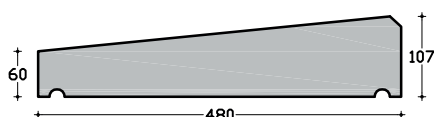
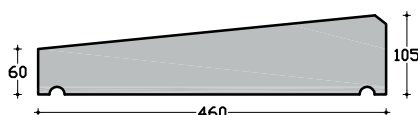
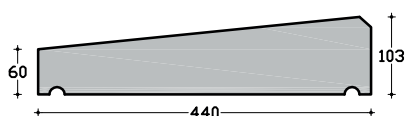
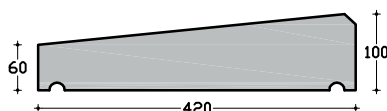
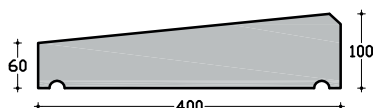
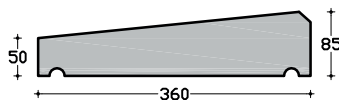
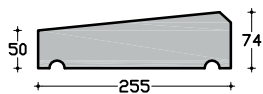

Art. nummer	Stuks per pallet	Gewicht per m ¹	Prijs m ¹ grijs	Prijs m ¹ antraciet
ABS25,5A	24	38	€ 35,82	€ 50,42
ABS36A	14	58	€ 52,50	€ 72,32
ABS40A	14	76	€ 62,76	€ 87,62
ABS42	14	81	€ 64,67	€ 89,87
ABS44A	14	86	€ 71,96	€ 98,92
ABS46	14	91	€ 78,57	€ 106,13
ABS48	14	96	€ 83,62	€ 118,31

Toepassing:

- Het afdekken van een borstwering, kopgevel of gemetselde tuinmuren.

Voordelen:

- snelle montage.
- voorkomt vochtopname van het onderliggende metselwerk.

Uitvoering:

- betonoppervlak conform klasse A.
- maximale lengte 1500 mm.
- variabele lengte mogelijk.
- met of zonder waterhol.
- kleur grijs of antraciet.
- andere kleuren projectmatig mogelijk.
- afwijkende maatvoering op aanvraag.

Opties:

- verstek 45°.
- hoekstuk 90°.
- verstek afwijkend.
- eindstuk max. 1500 mm.
- sparing.
- conische sparing.
- spouwnok.
- schroefhuls stortzijde.

Verwerking:

- in mortel te leggen en voegen van 10 mm te hanteren. Voegen afwerken met flexibele kit.



Muurafdekken

Toepassing:

- Het afdekken van een borstwering, kopgevel of gemetselde tuinmuren.

Voordelen:

- snelle montage.
- voorkomt vochtopname van het onderliggende metselwerk.

Uitvoering:

- betonoppervlak conform klasse A.
- maximale lengte 1500 mm.
- variabele lengte mogelijk.
- met of zonder waterhol.
- kleur grijs of antraciet.
- andere kleuren projectmatig mogelijk.
- afwijkende maatvoering op aanvraag.

Opties:

- verstek 45°.
- hoekstuk 90°.
- verstek afwijkend.
- eindstuk max. 1000 mm.
- sparing.
- conische sparing.
- spouwnok.
- schroefhuls stortzijde.

Verwerking:

- in mortel te leggen en voegen van 10 mm te hanteren. Voegen afwerken met flexibele kit.

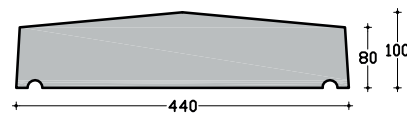
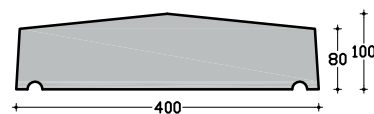
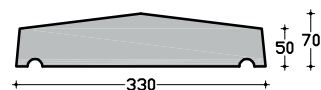
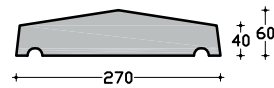
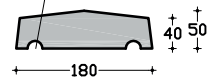
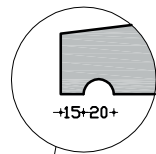

Art. nummer	Stuks per pallet	Gewicht per m ¹	Prijs m ¹ grijs	Prijs m ¹ antraciet
AB18	40	19	€ 23,55	€ 32,86
AB27	30	31	€ 30,90	€ 41,95
AB33	16	46	€ 44,03	€ 61,79
AB40A	16	85	€ 54,96	€ 76,94
AB44	16	94	€ 63,43	€ 89,22



Muurafdekken serie

50 serie + 60 serie (zie voor meer informatie pagina 17)

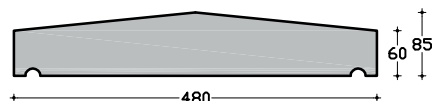
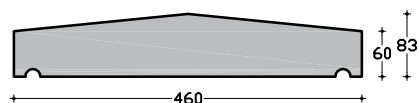
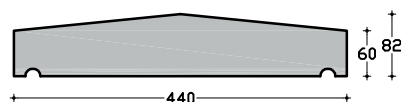
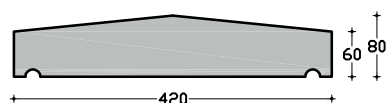
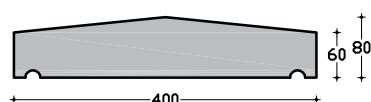
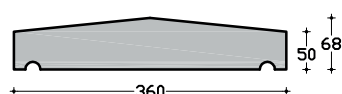
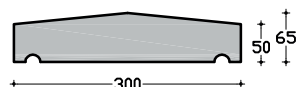
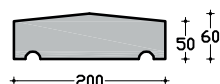
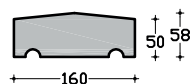

Art. nummer	Stuks per pallet	Gewicht per m ¹	Prijs m ¹ grijs	Prijs m ¹ antraciet
AB16	40	19	€ 22,94	€ 32,69
AB20	30	31	€ 24,16	€ 33,72
AB30	18	46	€ 36,34	€ 49,90
AB36A	16	51	€ 47,28	€ 70,40
AB40B	16	66	€ 53,89	€ 75,45
AB42	16	71	€ 58,24	€ 81,88
AB44A	16	75	€ 61,02	€ 86,23
AB46	14	78	€ 65,71	€ 91,97
AB48	14	83	€ 71,62	€ 101,89

Toepassing:

- Het afdekken van een borstwering, kopgevel of gemetselde tuinmuren.

Voordelen:

- snelle montage.
- voorkomt vochtopname van het onderliggende metselwerk.

Uitvoering:

- betonoppervlak conform klasse A.
- maximale lengte 1500 mm.
- variabele lengte mogelijk.
- met of zonder waterhol.
- kleur grijs of antraciet.
- andere kleuren projectmatig mogelijk.
- afwijkende maatvoering op aanvraag.

Opties:

- verstek 45°.
- hoekstuk 90°.
- verstek afwijkend.
- eindstuk max. 1500 mm.
- sparing.
- conische sparing.
- spouwnok.
- schroefhuls stortzijde.

Verwerking:

- in mortel te leggen en voegen van 10 mm te hanteren. Voegen afwerken met flexibele kit.



Muurafdekken

Toepassing:

- Het afdekken van een borstwering, kopgevel of gemetselde tuinmuren.

Voordelen:

- snelle montage.
- voorkomt vochtopname van het onderliggende metselwerk.

Uitvoering:

- betonoppervlak conform klasse A.
- maximale lengte 1200 mm.
- variabele lengte mogelijk.
- met of zonder waterhol.
- kleur grijs of antraciet.
- andere kleuren projectmatig mogelijk.
- afwijkende maatvoering op aanvraag.

Opties:

- verstek 45°.
- hoekstuk 90°.
- verstek afwijkend.
- eindstuk max. 1000 mm.
- sparing.
- conische sparing.
- spouwnok.
- schroefhuls stortzijde.

Verwerking:

- in mortel te leggen en voegen van 10 mm te hanteren. Voegen afwerken met flexibele kit.

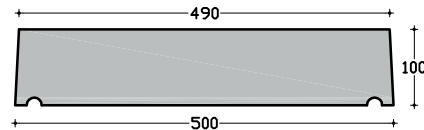
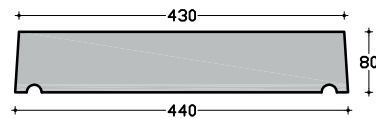
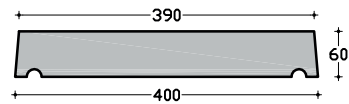
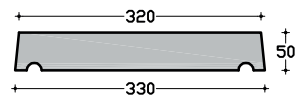
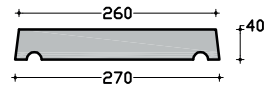
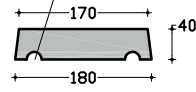
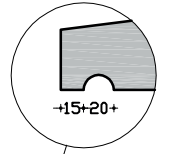

Art. nummer	Stuks per pallet	Gewicht per m ¹	Prijs m ¹ grijs	Prijs m ¹ antraciet
ABV18	40	19	€ 23,55	€ 32,86
ABV27	30	38	€ 30,89	€ 43,42
ABV33	20	54	€ 44,03	€ 61,79
ABV40	18	75	€ 53,95	€ 75,51
ABV44	16	93	€ 63,43	€ 89,22
ABV50	14	118	€ 82,31	€ 116,43

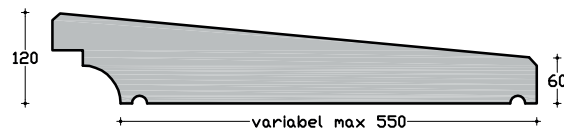

ABR550

126

prijs op aanvraag



Toeslagen zie pagina 33.

Overzicht aansluitende producten

50 serie

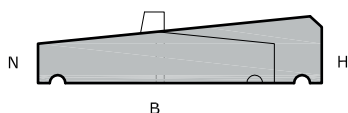
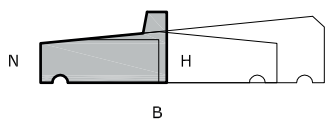

Art. nummer	N	B	H	Prijs m ¹ grijs	Prijs m ¹ antraciet
Raamdorpsels					
RD120B	50	120	85	€ 25,56	€ 38,33
RD160C	50	160	90	€ 29,30	€ 43,94
RD180B	50	180	95	€ 30,34	€ 45,52
Spekbanden					
SBA150C	50	150	55	€ 27,81	€ 38,94
SBN150C	50	150	114	€ 30,25	€ 42,68
Eenzijdig aflopende muurafdekken					
ABS25,5A	50	255	74	€ 35,82	€ 50,42
ABS36A	50	360	85	€ 52,50	€ 72,32
Tweezijdig aflopende muurafdekken					
AB16	50	160	58	€ 22,94	€ 32,69
AB20	50	200	60	€ 24,16	€ 33,72
AB30	50	300	65	€ 36,34	€ 49,90
AB36A	50	360	68	€ 47,28	€ 70,40

60 serie

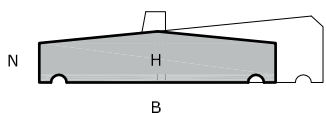
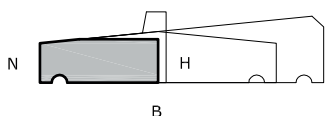

Art. nummer	N	B	H	Prijs m ¹ grijs	Prijs m ¹ antraciet
Raamdorpsels					
RD120C	60	120	95	€ 25,74	€ 38,60
RD140B	60	140	95	€ 26,69	€ 40,04
RD160D	60	160	100	€ 29,55	€ 44,33
RD180C	60	180	100	€ 30,78	€ 46,15
RD180D	60	180	110	€ 30,95	€ 46,41
Spekbanden					
SBA150D	60	150	65	€ 29,03	€ 40,64
SBN150D	60	150	114	€ 30,49	€ 43,59
Eenzijdig aflopende muurafdekken					
ABS40A	60	400	100	€ 62,76	€ 87,62
ABS42	60	420	100	€ 64,67	€ 89,87
ABS44A	60	440	103	€ 71,96	€ 98,92
ABS46	60	460	105	€ 78,57	€ 106,13
ABS48	60	480	107	€ 83,62	€ 118,31
Tweezijdig aflopende muurafdekken					
AB40B	60	400	80	€ 53,89	€ 75,45
AB42	60	420	80	€ 58,24	€ 81,88
AB44A	60	440	82	€ 61,02	€ 86,23
AB46	60	460	83	€ 65,71	€ 91,97
AB48	60	480	85	€ 71,62	€ 101,89

80 serie

Art. nummer	N	B	H	Prijs m ¹ grijs	Prijs m ¹ antraciet
Raamdorpsels					
RD160E	80	160	120	€ 31,39	€ 46,85
RD180F	80	180	125	€ 37,51	€ 52,97
Spekbanden					
SBA150E	80	150	90	€ 29,49	€ 41,94

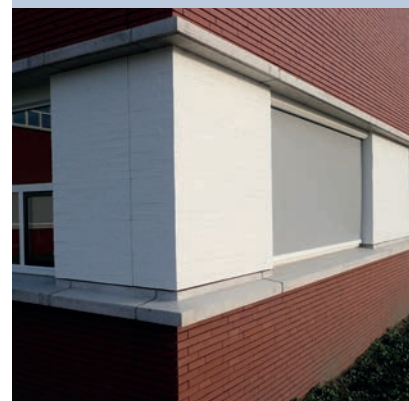

Penantafdekken / Schoorsteenplaten

Toepassing:

- afdekken van een schoorsteen en gemetselde poeren.

Voordelen:

- snelle montage.
- voorkomt vochtopname van het onderliggende metselwerk.

Uitvoering:

- betonoppervlak conform klasse A.
- waterhol rondom.
- waterhol Ø 20 mm, 15 mm vanaf zijkant.
- vierzijdig afwaterend.
- kleur grijs of antraciet.
- andere kleuren projectmatig mogelijk.
- afwijkende maatvoering op aanvraag.

Opties:

- sparing.
- conische sparing.
- schroefhuls stortzijde.
- vlakke bovenkant 150x150 mm tbv montage lamp.
- gat rond 20 mm tbv stroomdraad.
- bol op pilasterafdek gemonteerd door rvs schroefdraad.

Verwerking:

- in mortel te leggen.

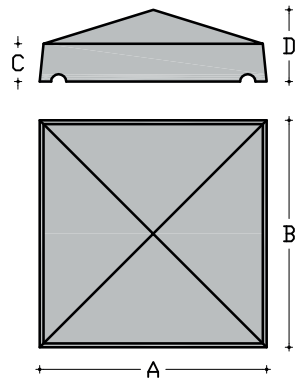

A	B	C	D	Art. nummer	Gewicht per stuk/kg	Prijs per stuk grijs	Prijs per stuk antraciet
180	180	40	50	PA18	4	€ 18,86	€ 26,37
280	280	40	60	PA28	9	€ 20,97	€ 29,36
300	400	50	90	PA30/40	20	€ 28,42	€ 39,81
350	350	50	95	PA35	20	€ 22,94	€ 32,12
400	400	50	105	PA40	28	€ 29,20	€ 40,87
400	500	50	100	PA40/50	36	€ 43,26	€ 60,57
500	500	50	95	PA50	42	€ 50,15	€ 70,21
600	600	50	95	PA60	60	€ 66,93	€ 93,70
650	650	60	100	PA65	81	€ 85,45	€ 119,59
700	700	50	105	PA70	82	€ 96,60	€ 135,24
720	720	50	105	PA72	85	€ 100,13	€ 140,19
860	860	60	180	PA86	213	€ 161,14	€ 225,59
1000	1000	80	140	PA100	264	€ 178,83	€ 250,33
1200	1200	80	200	PA120	483	€ 193,29	€ 270,57

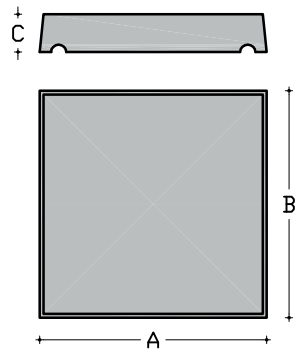

180	180	40		PAV18	3	€ 18,86	€ 26,37
280	280	40		PAV28	8	€ 20,97	€ 29,36
300	400	50		PAV30/40	15	€ 28,42	€ 39,81
350	350	50		PAV35	15	€ 22,94	€ 32,12
400	400	50		PAV40	20	€ 29,20	€ 40,87
400	500	50		PAV40/50	24	€ 43,26	€ 60,57
500	500	50		PAV50	30	€ 50,15	€ 70,21
600	600	50		PAV60	44	€ 66,93	€ 93,70
650	650	60		PAV65	61	€ 85,45	€ 119,59
700	700	50		PAV70	59	€ 96,60	€ 135,24
720	720	50		PAV72	62	€ 100,13	€ 140,19
860	860	60		PAV86	107	€ 161,14	€ 225,59
1000	1000	80		PAV100	192	€ 178,83	€ 250,33
1200	1200	80		PAV120	277	€ 193,29	€ 270,57

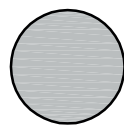

200

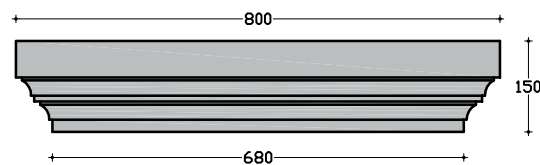
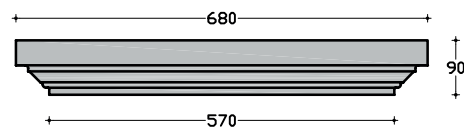
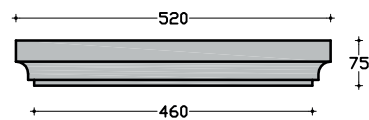

Stortzijde is bovenzijde

PB20 14 € 48,77 € 68,44

PA46P 44 € 66,41 € 99,61

PA57P 90 € 116,32 € 174,46

PA68P 201 € 166,20 € 249,30





14 Woningen te Nijmegen

Slokker Bouwgroep



Bocht van Maarsen

Toepassing:

- afdekken van een schoorsteen en gemetselde poeren.

Voordelen:

- snelle montage.
- voorkomt vochtopname van het onderliggende metselwerk.

Uitvoering:

- betonoppervlak conform klasse A.
- waterhol rondom.
- waterhol Ø20 mm, 15 mm vanaf zijkant.
- kleur grijs.
- andere kleuren projectmatig mogelijk.
- afwijkende maatvoering op aanvraag.

Opties:

- sparingen.
- schoorsteenpotten.
- schroefhuls stortzijde.
- gat rond 20 mm tbv stroomdraad.
- bol op pilasterafdek gemonteerd door rvs schroefdraad.

Verwerking:

- in metselspecie te leggen.

Met profilering

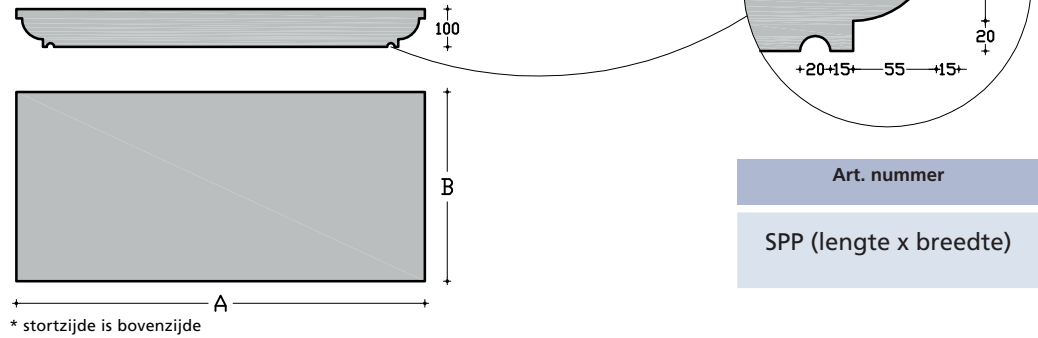

* stortzijde is bovenzijde

Art. nummer

SPP (lengte x breedte)

Lengte A(mm)	Breedte B (mm)						
	500-599	600-699	700-799	800-899	900-999	1000-1099	1100-1200
500-599	€ 105,53						
600-699	€ 119,48	€ 136,31					
700-799	€ 133,44	€ 152,30	€ 171,16				
800-899	€ 147,41	€ 168,30	€ 189,18	€ 210,07			
900-999	€ 161,36	€ 184,26	€ 207,16	€ 230,07	€ 252,97		
1000-1099	€ 175,31	€ 200,24	€ 225,18	€ 250,11	€ 275,04	€ 299,98	
1100-1199	€ 189,28	€ 216,24	€ 243,21	€ 270,17	€ 297,13	€ 324,09	€ 351,06
1200-1299	€ 203,23	€ 232,21	€ 261,19	€ 290,16	€ 319,14	€ 348,11	€ 377,09
1300-1399	€ 217,19	€ 248,19	€ 279,20	€ 310,20	€ 341,21	€ 372,22	€ 403,22
1400-1499	€ 231,15	€ 264,19	€ 297,23	€ 330,26	€ 363,30	€ 396,33	€ 429,37
1500-1599	€ 245,11	€ 280,16	€ 315,21	€ 350,26	€ 385,31	€ 420,36	€ 455,40
1600-1699	€ 259,06	€ 296,14	€ 333,22	€ 370,30	€ 407,38	€ 444,46	€ 481,54
1700-1799	€ 273,03	€ 312,14	€ 351,25	€ 390,36	€ 429,47	€ 468,57	€ 507,68
1800-1899	€ 286,98	€ 328,10	€ 369,23	€ 410,35	€ 451,47	€ 492,60	€ 533,72
1900-2000	€ 300,93	€ 344,09	€ 387,24	€ 430,39	€ 473,54	€ 516,70	€ 559,85

* bovenstaande prijzen zijn in de kleur grijs

* prijzen antraciet op aanvraag

* Elke willekeurige lengte- en breedtemaat te bestellen

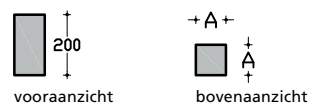
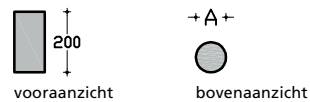

Art. nummer	A	Prijs per stuk grijs
SPK1	100	€ 23,98
SPK2	140	€ 31,96

SPK3	100	€ 23,98
SPK4	140	€ 31,96

montagekosten dubbele schoorsteenplaat
(onderplaat-kolommen-bovenplaat)

€ 151,84

Vlak

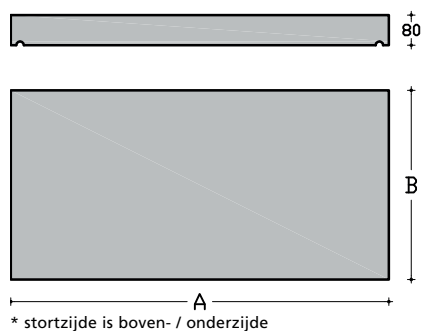

Art. nummer

SPV (lengte x breedte)

Lengte A(mm)	Breedte B (mm)						
	500-599	600-699	700-799	800-899	900-999	1000-1099	1100-1200
500-599	€ 75,37						
600-699	€ 85,35	€ 97,37					
700-799	€ 95,32	€ 108,79	€ 122,27				
800-899	€ 105,29	€ 120,20	€ 135,12	€ 150,03			
900-999	€ 115,25	€ 131,62	€ 147,98	€ 164,35	€ 180,71		
1000-1099	€ 125,22	€ 143,03	€ 160,83	€ 178,64	€ 196,44	€ 214,25	
1100-1199	€ 135,20	€ 154,45	€ 173,71	€ 192,97	€ 212,23	€ 231,49	€ 250,75
1200-1299	€ 145,17	€ 165,87	€ 186,56	€ 207,26	€ 227,96	€ 248,66	€ 269,35
1300-1399	€ 155,14	€ 177,29	€ 199,45	€ 221,60	€ 243,75	€ 265,90	€ 288,05
1400-1499	€ 165,11	€ 188,72	€ 212,33	€ 235,93	€ 259,54	€ 283,15	€ 306,75
1500-1599	€ 175,07	€ 200,12	€ 225,16	€ 250,21	€ 275,25	€ 300,29	€ 325,34
1600-1699	€ 185,05	€ 211,53	€ 238,01	€ 264,49	€ 290,98	€ 317,46	€ 343,94
1700-1799	€ 195,02	€ 222,96	€ 250,89	€ 278,83	€ 306,77	€ 334,71	€ 362,64
1800-1899	€ 204,99	€ 234,37	€ 263,74	€ 293,12	€ 322,49	€ 351,87	€ 381,25
1900-2000	€ 214,96	€ 245,79	€ 276,62	€ 307,45	€ 338,29	€ 369,12	€ 399,95

* bovenstaande prijzen zijn in de kleur grijs

* prijzen antraciet op aanvraag

* Elke willekeurige lengte- en breedtemaat te bestellen



Ornamenten

Toepassing:

- ter versiering van de gevel en/of het bouwwerk.

Voordelen:

- snelle montage.
- voorkomt vochtopname van het onderliggende metselwerk.

Uitvoering:

- betonoppervlak conform klasse A.
- kleur grijs.
- andere kleuren projectmatig mogelijk.
- afwijkende maatvoering op aanvraag.

Opties:

- sparing.
- conische sparing.
- schroefhuls stortzijde.
- gat rond 20 mm tbv stroomdraad.

Verwerking:

- in metselspecie te leggen.

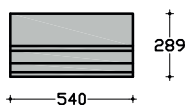
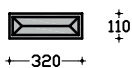
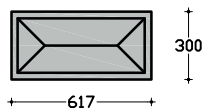
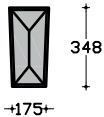
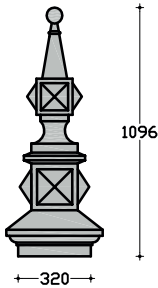
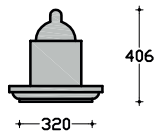

Art. nummer	Prijs per stuk grijs
OR05	€ 513,52
OR06	€ 1450,89
OR07	€ 448,31
OR08	€ 268,98
OR09	€ 127,16
OR10	€ 220,08
OR11	€ 105,97
OR12	€ 187,47





Neck

Herontwikkeling





Brugrand B-Ton

Mosselsingel Den Haag



20 Landhoofden

Alkmaar

Kantplanken

Kantplank met sponning

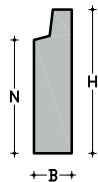

Art. nummer	B	N	H	Stuks p. pallet	Gewicht per m ¹	Prijs per m ¹
KP5x15S	50	110	150	48	18	€ 14,03
KP6x15S	60	110	150	48	22	€ 15,00
KP5x19S	50	150	190	42	23	€ 15,96
KP5x20S	50	160	200	42	24	€ 16,08
KP6x20S	60	160	200	38	29	€ 17,51
KP5x25S	50	210	250	35	26	€ 19,32
KP6x25S	60	210	250	32	36	€ 20,29
KP5x30S	50	260	300	35	37	€ 21,27
KP5x33S	50	290	330	20	40	€ 22,14
KP5x35S	50	310	350	20	42	€ 22,94
KP6x40S	60	360	400	20	58	€ 25,56
KP6x44S	60	400	440	20	64	€ 27,87

Toepassing:

- aansluiting tussen kozijn en fundering.

Voordelen:

- snelle montage.
- voorkomt het optrekken van vocht.

Uitvoering:

- betonoppervlak conform klasse A.
- standaard lengte 1025 mm.
- standaard lengte 1500 mm.
- variabele lengte mogelijk.
- met of zonder sponning.
- kleur grijs.
- andere kleuren projectmatig mogelijk.
- afwijkende maatvoering op aanvraag.

Opties:

- verstek 45°.
- verstek afwijkend.
- sparing.
- schroefhuls stortzijde.

Verwerking:

- staand in mortel te plaatsen en voegen van 10 mm te hanteren. Voegen afwerken met flexibele kit.

Kantplank zonder sponning

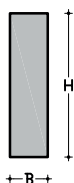

Art. nummer	B	H	Stuks p. pallet	Gewicht per m ¹	Prijs per m ¹
KP5x15R	50	150	48	18	€ 14,03
KP6x15R	60	150	48	22	€ 15,00
KP5x19R	50	190	42	23	€ 15,96
KP5x20R	50	200	42	24	€ 16,08
KP6x20R	60	200	38	29	€ 17,51
KP5x25R	50	250	35	26	€ 19,32
KP6x25R	60	250	32	36	€ 20,29
KP5x30R	50	300	35	37	€ 21,27
KP5x33R	50	330	20	40	€ 22,14
KP5x35R	50	350	20	42	€ 22,94
KP6x40R	60	400	20	58	€ 25,56
KP6x44R	60	440	20	64	€ 27,87



Bloktreden

Uitvoering:

- betonoppervlak conform klasse A.
- variabele lengte mogelijk.
- kleur grijs of antraciet.
- andere kleuren projectmatig mogelijk.
- afwijkende maatvoering op aanvraag.

Opties:

- verstek 45°.
- hoekstuk 90°.
- verstek afwijkend.
- sparing.
- schroefhuls stortzijde.
- dragend uitgevoerd.

Verwerking:

- in mortel te leggen en voegen van 10 mm te hanteren. Voegen afwerken met flexibele kit.

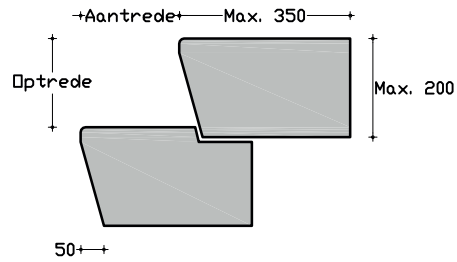

variabele sponningmaten
waardoor de op- en aantrede
bepaald worden

Art. nummer	Gewicht per m ¹	Prijs m ¹ grijs	Prijs m ¹ antraciet
BTA	158	€ 73,02	€ 102,23

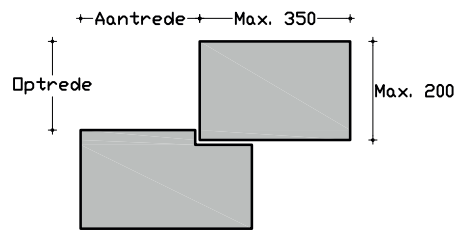

variabele sponningmaten
waardoor de op- en aantrede
bepaald worden

Art. nummer	Gewicht per m ¹	Prijs m ¹ grijs	Prijs m ¹ antraciet
BTB	168	€ 64,33	€ 90,05

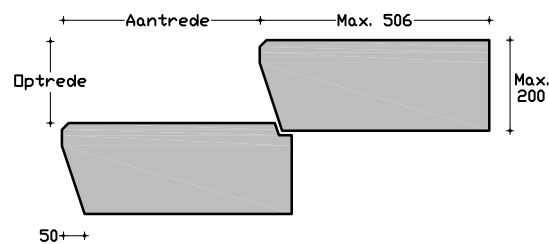

variabele sponningmaten
waardoor de op- en aantrede
bepaald worden

Art. nummer	Gewicht per m ¹	Prijs m ¹ grijs	Prijs m ¹ antraciet
BTC	232	€ 91,36	€ 127,90



Algemeen:

- Maximale lengte bloktreden 3000 mm
- Bloktreden zijn standaard voorzien van transportwapening.
- Bloktreden uitvoeren met constructieve wapening is mogelijk tegen meerprijs (op aanvraag).

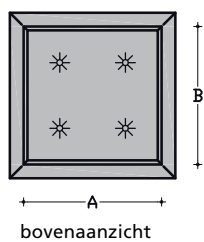

bovenaanzicht

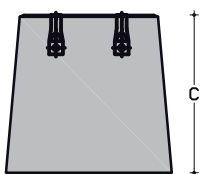

vooraanzicht

Art. nummer	A	B	C	Prijs per stuk grijs
FD30	300	300	300	€ 32,63
FD35/40	350	300	400	€ 54,38
FD40	400	400	400	€ 73,91
FD40/30	400	300	300	€ 56,53
FD45	450	450	150	€ 65,24
FD45/30	450	300	300	€ 78,28
FD50	500	500	500	€ 97,27
FD60/30	600	300	150	€ 50,02
FD60/20	600	200	300	€ 43,48

positie schroefhulzen op aanvraag
schroefhulzen zijn exclusief

Uitvoering:

- betonoppervlak conform klasse A.
- kleur grijs.
- afwijkende maatvoering op aanvraag.

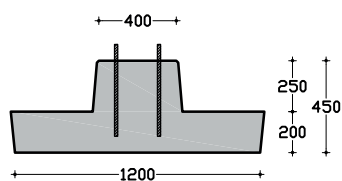

vooraanzicht

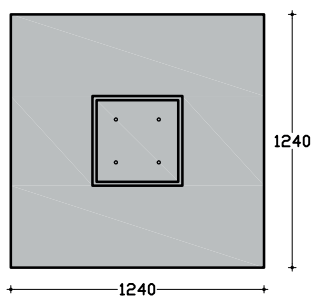

bovenaanzicht

Art. nummer	Prijs per stuk grijs
PR01	€ 208,85

positie draadeinden op aanvraag
draadeinden zijn exclusief

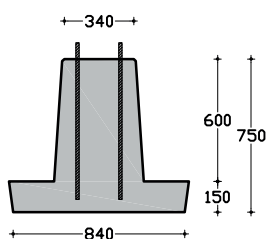

vooraanzicht

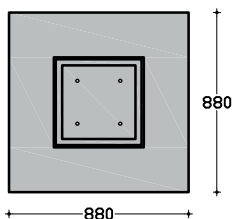

bovenaanzicht

Art. nummer	Prijs per stuk grijs
PR02	€ 174,27

positie draadeinden op aanvraag
draadeinden zijn exclusief

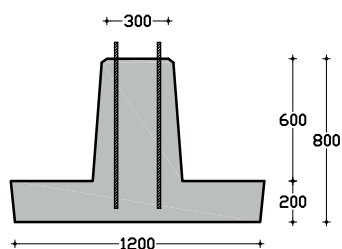

vooraanzicht

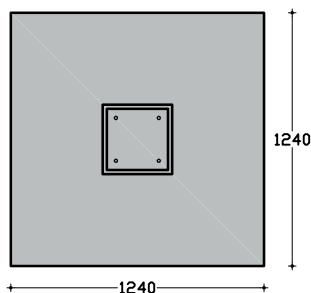

bovenaanzicht

Art. nummer	Prijs per stuk grijs
PR03	€ 225,29

positie draadeinden op aanvraag
draadeinden zijn exclusief



Deuromlijstingen

Uitvoering:

- betonoppervlak conform klasse A.
- variabele lengte mogelijk.
- kleur grijs of antraciet.
- andere kleuren projectmatig mogelijk.
- afwijkende maatvoering op aanvraag.

Opties:

- sparing.
- conische sparing.
- schroefhuls stortzijde.

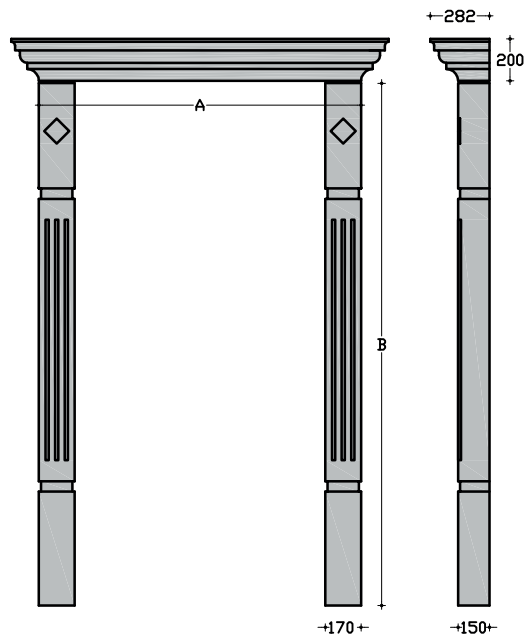

A = max.2000 mm
B = max.3000 mm

Art. nummer	Prijs m ¹ grijs	Prijs m ¹ antraciet
BD01 bovendorpel	€ 182,54	€ 255,56
ST01 stijl	€ 95,62	€ 133,86

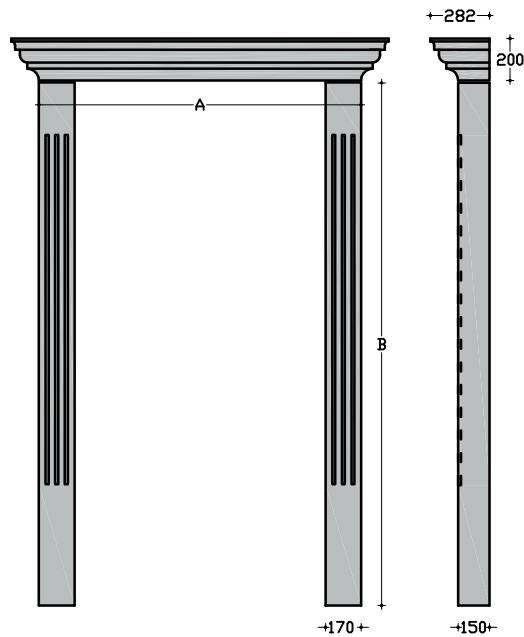

A = max.2000 mm
B = max.3000 mm

Art. nummer	Prijs m ¹ grijs	Prijs m ¹ antraciet
BD02 bovendorpel	€ 182,54	€ 255,56
ST02 stijl	€ 92,15	€ 128,65



- Deuromlijstingen zijn standaard voorzien van praktische wapening.
Deuromlijstingen uitvoeren met constructieve wapening is mogelijk tegen meerprijs (op aanvraag).

Deuromlijstingen

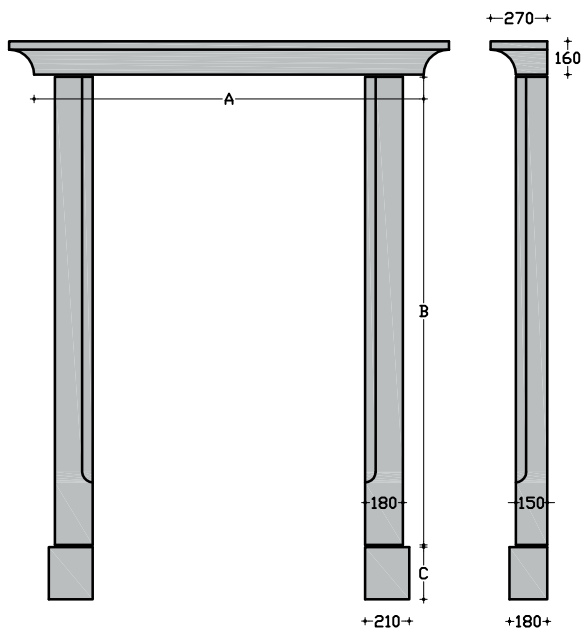

A = max.2500 mm
B = max.3000 mm
C = max. 500 mm

Art. nummer	Prijs m ¹ grijs	Prijs m ¹ antraciet
BD03 bovendorpel	€ 187,75	€ 262,51
ST03 stijl	€ 112,99	€ 158,20

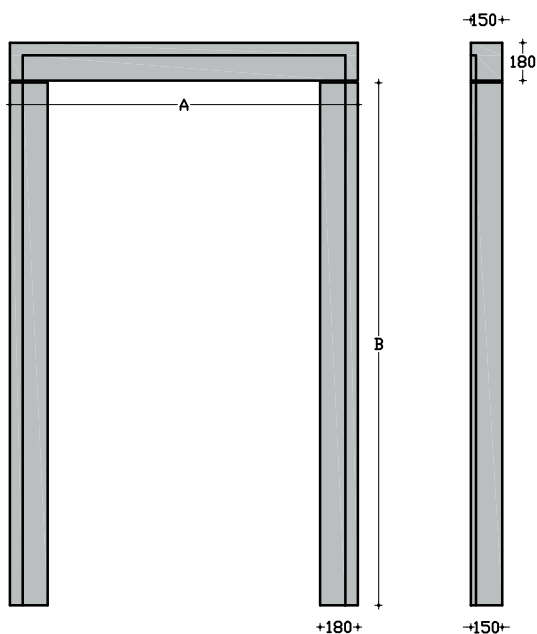

A = max.2500 mm
B = max.3000 mm

Art. nummer	Prijs m ¹ grijs	Prijs m ¹ antraciet
BD04 bovendorpel	€ 144,30	€ 201,67
ST04 stijl	€ 85,18	€ 118,22



Raamkaders

Uitvoering:

- betonoppervlak conform klasse A.
- variabele lengte mogelijk.
- kleur grijs of antraciet.
- andere kleuren projectmatig mogelijk.
- afwijkende maatvoering op aanvraag.

Opties:

- sparing.
- conische sparing.
- schroefhuls stortzijde.

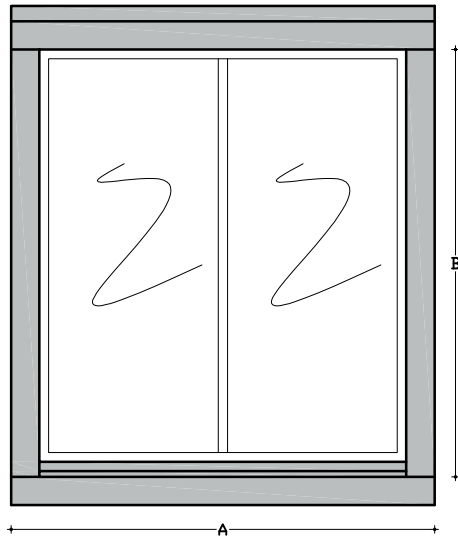

A = max.2000 mm
B = max.2000 mm

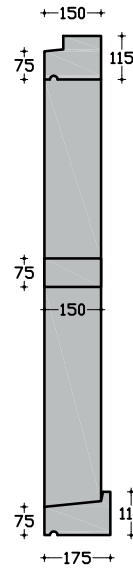

Art. nummer	Prijs m ¹ grijs	Prijs m ¹ antraciet
BD05 bovendorpel	€ 50,28	€ 69,96
ST05 stijl	€ 67,89	€ 98,37
OD05 onderdorpel	€ 30,19	€ 45,31

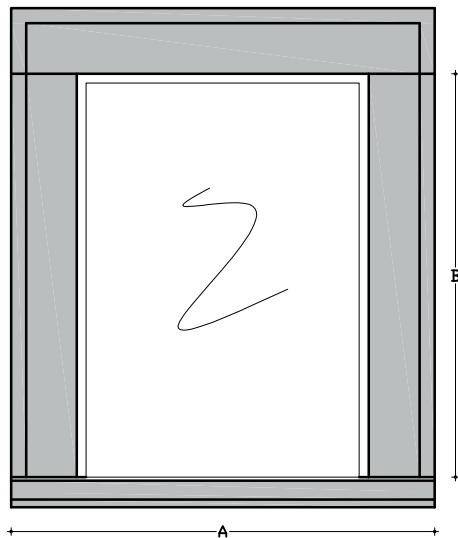

A = max.2000 mm
B = max.2000 mm

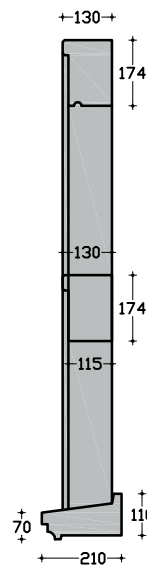

Art. nummer	Prijs m ¹ grijs	Prijs m ¹ antraciet
BD06 bovendorpel	€ 124,56	€ 180,71
ST06 stijl	€ 81,65	€ 118,37
OD06 onderdorpel	€ 63,29	€ 94,92





Bocht van Maarsse

Sportparkweg
Maarsse (Utrecht)



Verwerkingsadvies ten behoeve van:

- afdekkbanden
- spekkbanden
- raamdorpels
- kantplanken

De hierboven genoemde prefab elementen worden veelal toegepast in combinatie met metselwerk. De uitzettingscoëfficiënten van metselwerk en beton zijn niet aan elkaar gelijk. Om spanningen ten gevolge van temperatuurveranderingen te voorkomen dienen we voegen toe te passen.

Een open stootvoeg (detail A) dient minimaal 5 mm breed te zijn.

Voor een kitvoeg op een rugvulling (detail B + C) dient de voegbreedte minimaal 10 mm te zijn.

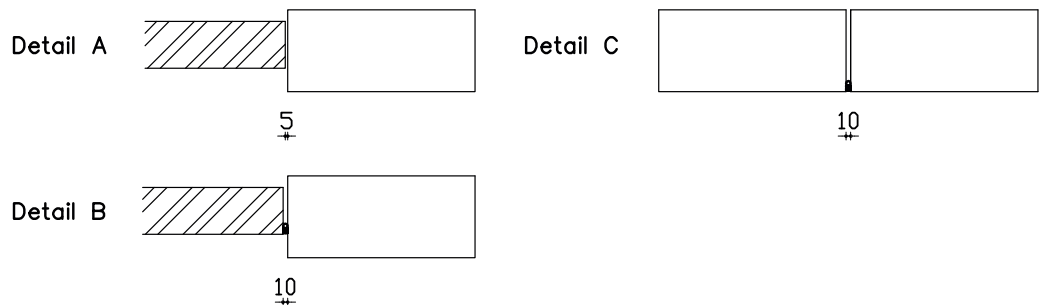

Hoekstukken

← A → 100 →

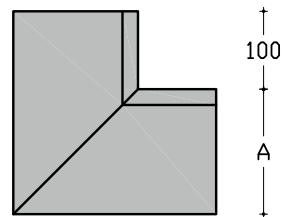

A = breedte doorsnede

lengte hoekstuk = A + 200 mm

Voorbeeld 1:

als voorbeeld de RDH160A, kleur grijs = € 28,99 / m¹

Kosten hoekstuk = (lengte x meterprijs) + toeslag € 12,50
= (0,36 x € 28,99) + € 12,50 = € 22,94

← A → 100 →

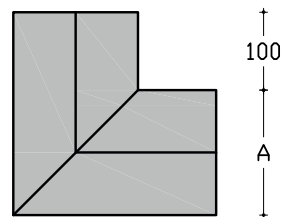

Voorbeeld 2:

als voorbeeld de ABH36A, kleur grijs = € 47,28 / m¹

Kosten hoekstuk = (lengte x meterprijs) + toeslag € 12,50
= (0,56 x € 47,28) + € 12,50 = € 38,98

Toeslagen

sparingen	conische sparing	€ 4,00
schroefhulzen	M8	€ 3,00
	M10	€ 3,75
	M12	€ 4,25
	M16	€ 6,00
hijsvoorzieningen	max. 2500 kg	€ 5,25
	max. 5000 kg	€ 6,75
diverse	eindstuk	€ 13,25
	omloopkop	€ 13,25
	verstek 45 graden tot 200 mm	€ 10,50
	verstek 45 graden breder dan 200 mm	€ 15,75
	spouwnokken 80x100x40 mm	€ 4,75
	neuten	op aanvraag
	spijkerklossen	€ 4,00
reparatiemortel	emmer 2,5 kg	€ 15,75
	emmer 5,0 kg	€ 31,50
	emmer 12 kg	€ 63,00
impregneer	fles 0,5 liter	€ 10,50
	fles 1 liter	€ 15,75
	kan 5 liter	€ 63,00
transport	1 europallet	€ 165,00
	2 europallets	€ 200,00
	3 europallets	€ 235,00
	4 europallets	€ 270,00
	5 europallets	op aanvraag
	europallet (statiegeld)	€ 15,00
tekenkosten	tekenkosten € 60,- per uur	
algemeen	toeslag order < € 100,00 prijzen zijn af fabriek elementen lengte ≤ 1000 mm wordt gerekend als zijnde lengte = 1000 mm alle prijzen zijn excl. btw	€ 12,50



Geleverde goederen kunnen niet geretourneerd worden.



Nijverheidsweg 6
Bedrijventerrein Nijnsel
5492 NK Sint-Oedenrode
Tel. 0413-476757
E-mail info@bsbeton.nl
Internet www.bsbeton.nl

